

## LAMIERA A FREDDO - KALTGEWALZTES BLECH

UNI EN 10131 DIN EN 10131

Spessore Dicke mm	Peso Gewicht Kg/m <sup>2</sup>	Dimensioni - Abmessungen mm			Spessore Dicke mm	Peso Gewicht Kg/m <sup>2</sup>	Dimensioni - Abmessungen mm		
		2000x1000	2500x1250	3000x1500			2000x1000	2500x1250	3000x1500
		Peso - Gewicht Kg					Peso - Gewicht Kg		
0,3	2,4	4,8	7,48	10,8	1,2	9,42	18,8	29,5	42
0,4	3,2	6,4	9,98	14,4	1,5	11,8	23,6	36,7	53
0,5	4	8	12,48	18	2	15,7	31,4	49	71
0,6	4,8	9,6	14,97	21,6	2,5	19,6	39,3	61	88
0,8	6,4	12,8	19,96	28,8	3	23,6	47,1	73	106
1	7,85	15,7	24,5	35					

## LAMIERA DA COILS - WARMGEWALZTES BLECH

Nera-decapata - Schwarz-Gebeizt

EU 29 - UNI EU 29 - DIN 1016 - DIN EN 10029

Spessore Dicke mm	Peso Gewicht Kg/m <sup>2</sup>	Dimensioni - Abmessungen mm						
		1000 x 2000	1250 x 2500	1500 x 3000	1500 x 6000	1800 x 6000	2000 x 6000	2000 x 8000
		Peso - Gewicht Kg						
1,5	11,8	23,6	36,7	53	-	-	-	-
1,8	14,1	28,2	44,2	64	-	-	-	-
2,0	15,7	31,4	49,0	71	-	-	-	-
2,5	19,6	39,3	61,0	88	-	-	-	-
3,0	23,6	47,1	73,0	106	212,4	255	282,6	376,8
3,5	27,5	55,0	86,0	124	-	-	-	-
4,0	31,4	62,8	98,0	141	282,6	339	377,0	502,4
5,0	39,3	78,5	123,0	176	352,0	424	472,0	628,0
6,0	47,1	94,2	147,0	212	424,0	509	565,0	753,0
7,0	55,0	110,0	172,0	247	494,0	594	660,0	879,0
8,0	62,8	126,0	196,0	282	564,0	678	754,0	1004,0
9,0	70,6	141,0	221,0	318	636,0	762	847,0	1130,0
10,0	78,5	157,0	245,0	353	706,0	848	942,0	1256,0

## LAMIERA ZINCATA - VERZINKTES BLECH

UNI 5763 - DIN EN 10142

N° calibro Kaliber Nr.	Spessore Dicke mm	Peso Gewicht Kg/m <sup>2</sup>	N° calibro Kaliber Nr.	Spessore Dicke mm	Peso Gewicht Kg/m <sup>2</sup>	N° calibro Kaliber Nr.	Spessore Dicke mm	Peso Gewicht Kg/m <sup>2</sup>
34	0,20	1,75	27	0,45	3,91	20	1,00	8,25
33	0,23	1,99	26	0,50	4,30	18	1,25	9,90
32	0,25	2,14	25	0,55	4,70	17	1,50	12,15
31	0,27	2,30	24	0,60	5,10	14	2,00	16,10
30	0,30	2,73	23	0,70	5,90	12	2,50	20,05
29	0,35	3,13	22	0,80	6,65	10	3,00	29,35
28	0,40	3,52						

## LAMIERA DA TRENO - WARMGEWALZTES DICKES BLECH

UNI EU 29 - DIN EN 10029

Spessore Dicke mm	Peso Gewicht Kg/m <sup>2</sup>	Dimensioni - Abmessungen mm						
		2000 x 6000	2500 x 6000	2000 x 8000	2500 x 8000	2500 x 10000	2500 x 12000	3000 x 12000
Peso - Gewicht Kg								
6	47,10	566	707	754	942	1178	1413	-
7	54,95	660	825	880	1099	1374	1649	-
8	62,80	754	942	1105	1256	1570	1884	2261
9	70,65	848	1060	1131	1413	1767	2120	2544
10	78,50	942	1178	1256	1570	1963	2355	2826
12	94,20	1131	1413	1508	1884	2355	2826	3392
13	102,05	1225	1531	1633	2041	2552	3062	3674
14	109,90	1319	1649	1759	2198	2748	3297	3957
15	117,75	1413	1767	1884	2355	2940	3533	4239
16	125,60	1508	1884	2010	2512	3140	3768	4522
18	141,30	1696	2120	2261	2826	3533	4239	5087
20	157,00	1884	2355	2512	3140	3925	4710	5652
22	172,70	2073	2591	2764	3454	4318	5181	6218
25	195,25	2355	2944	3140	3925	4907	5888	7065
26	204,10	2450	3062	3266	4082	5103	6123	7348
28	219,80	2638	3297	3517	4396	5495	6594	7913
30	235,50	2826	3533	3768	4710	5888	7065	8478
35	274,75	3297	4122	4396	5495	6869	8243	9891
40	314,00	3768	4710	5024	6280	7850	9420	11304
45	353,25	4239	5299	5652	7065	8832	10598	-
50	392,50	4710	5888	6280	7850	9813	11775	-
55	431,75	5181	6477	6908	8635	10794	12953	-
60	471,00	5652	7065	7536	9420	11775	14130	-
65	510,25	6123	7654	8164	10205	12757	15308	-
70	549,50	6594	8243	8792	10990	13738	16485	-
75	598,75	7065	8832	9420	11775	14719	17663	-
80	628,00	7536	9420	10048	12560	15700	18840	-
85	667,25	8007	10009	10676	13345	16682	20018	-
90	706,50	8478	10598	11304	14130	17663	21195	-
95	745,75	8949	11187	11932	14915	18644	22373	-
100	785,00	9420	11775	12560	15700	19625	23550	-
110	863,50	10362	12953	13816	17270	21558	-	-
120	942,00	11304	14130	15072	18840	23550	-	-
125	981,25	11775	14719	15700	19625	-	-	-
130	1020,50	12246	15308	16328	20410	-	-	-
140	1099,00	13188	16485	17584	21980	-	-	-
150	1177,50	14130	17663	18840	23550	-	-	-

## LAMIERA ANTIUSURA - VERSCHLEISSFESTES STAHLBLECH "HB 400"

### Analisi di colata - Schmelzanalyse in %

C	Si	Mn	P	S	Cr	Mo	Ni	Al
ca. 0,18	ca. 0,50	ca. 1,40	max. 0,015	max. 0,005	max. 1,20	ca. 0,50	max. 1,20	min. 0,015

### Proprietà meccaniche - Mechanische Eigenschaften ( Spessore lamiera-Blechdicke ≤60)

Durezza-Härte HB	R <sub>e</sub> MPa	R <sub>m</sub> MPa	A <sub>5</sub> %	Ak (-20°C) J/cm <sup>2</sup>
360 - 440	1100	1300	12	35

## LAMIERA IN ACCIAIO A GRANO FINE BONIFICATA HOCHFESTE, VERGÜTETE FEINKORNBAUSTÄHLE S 690

### Analisi di colata - Schmelzanalyse in %

C	Si	Mn	P	S	Cr	Mo	Ni	Al
ca. 0,20	ca. 0,80	ca. 1,70	max. 0,020	max. 0,015	max. 1,50	ca. 0,70	max. 1,50	min. >0,015

### Proprietà meccaniche - Mechanische Eigenschaften ( Spessore lamiera-Blechdicke ≤60)

Spessore lamiera - Blechdicke mm	R <sub>e</sub> MPa	R <sub>m</sub> MPa	A %
≤ 50	690	770 - 940	14
> 50 ≤ 100	650	760 - 930	14
> 100	630	710 - 900	14

## LAMIERA COR-TEN – COR-TEN-BLECH

### Analisi di colata - Schmelzanalyse in %

	C	Mn	Si	P	Smax	Al	V	Ni	Cr	Cu
COR-TEN A	≤ 0,12	0,20-0,50	0,25-0,75	0,07-0,15	0,050	-	-	≤ 0,65	0,30-1,25	0,25-0,55
COR-TEN A	< 0,19	0,80-1,25	0,30-0,65	≤ 0,04	0,050	0,015-0,06	0,02-0,10	0,15-0,40	0,40-0,65	0,25-0,40

### Proprietà meccaniche - Mechanische Eigenschaften

	Rm N/mm <sup>2</sup> min.			Rm H/mm <sup>2</sup> min.			A min. %				
Spessori mm <	1,5	6	12,7	<	1,5	6	12,7	<	1,5	6	12,7
Dicte mm	1,5	6	12,7	100,0	1,5	6	12,7	100	1,5	6	12,7
COR-TEN A 445	420	485	-	310	345	345	-	22	20	20	-
COR-TEN B	-	-	485	485,0	-	-	345	345	-	-	19

## LAMIERA BUGNATA - BUCKELBLECH

UNI EN 4630 - DIN 59220

Spessore Dicke mm	Peso Gewicht Kg/m <sup>2</sup>	Dimensioni - Abmessungen mm		
		2000x1000	2500x1250	3000x1500
		Peso - Gewicht Kg		
2,0	17,36	34,72	54,25	72,12
2,5	21,75	43,50	68,00	97,90
3	26,05	52,10	81,10	117,00
4	33,95	67,90	106,00	153,00
5	41,75	83,50	130,10	187,60
6	49,60	99,20	154,00	223,00
8	65,30	130,60	204,00	284,00
10	81,10	162,20	250,00	365,00

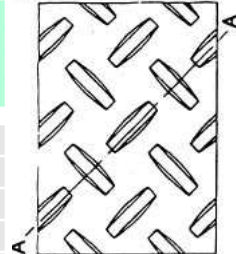

## LAMIERA STRIATA - RIFFELBLECH

EU 3151 - DIN 59220

Spessore Dicke mm	Peso Gewicht Kg/m <sup>2</sup>	Dimensioni - Abmessungen mm		
		1000x2000	1250x2500	1500x3000
		Peso - Gewicht Kg		
2	18,2	36,4	-	-
2,5	22,2	45,0	69,0	100,0
3	28,6	57,2	89,4	128,7
4	36,5	73,0	114,0	164,3
5	44,3	88,6	138,5	199,4
5	52,1	104,2	163,0	234,5
7	60,0	120,0	187,5	270,0
8	67,8	135,6	211,9	305,1
10	83,6	167,2	261,2	376,2
12	99,1	198,2	309,7	446,0

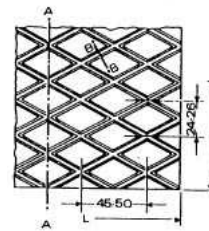

## LAMIERA MANDORLATA - MANDELBLECH

in alluminio - in Aluminium

EU 3151 - DIN 59220

A	Dimensioni - Abmessungen mm		C	Peso - Gewicht Kg/foglio
	B			
1000	2000		3+mandorle	18,5
1250	2500		3+mandorle	29,0
1500	3000		3+mandorle	41,0



## LAMIERA FORATA - LOCHBLECH

Formato - Format 2000 x 1000

### FORI TONDI - RUNDLÖCHER

foro Loch Ø	Passo Abstand mm	Spessore Dicke mm	Peso Gewicht Kg/m <sup>2</sup> (Spessore-Stärke 1,5)
2	3,5	1,5	16,80
3	5	1,5-2-3	16,15
4	7	1,5-2-3	16,15
5	8	1,5-2-3	15,80
6	9	1,5-2-3	14,40
8	12	1,5-2-3-4	14,40
10	15	1,5-2-3-4-5-6	13,90

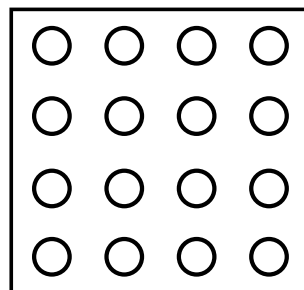

### FORI QUADRI-VIERKANTLÖCHER

foro Loch Ø	Passo Abstand mm	Spessore Dicke mm	Peso Gewicht Kg/m <sup>2</sup> (Spessore-Stärke 1,5)
5 x 5	7	1,5	11,76
8 x 8	10	1,5	8,70
8 x 8	12	1,5	13,35
10 x 10	13	1,5	9,80
10 x 10	15	1,5	10,90

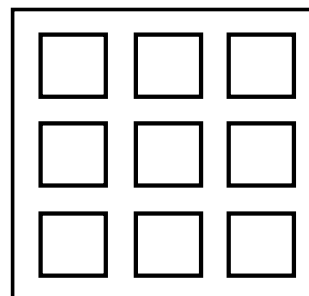

### RETI ONDULATE - GEWELLTE GITTER

IN ROTOLI O PANNELLI - IN ROLLEN ODER MATTEN

Maglia Masche mm	Filo Draht mm	Altezza Höhe mm	Peso Gewicht Kg/m <sup>2</sup>
10 x 10	2,0	1000	4,50
15 x 15	2,4	1000	4,60
20 x 20	3,0	1000	5,60
25 x 25	3,0	1000	4,80
30 x 30	3,5	1000	4,80
40 x 40	4,0	1000	5,30
50 x 50	5,0	1000	6,90

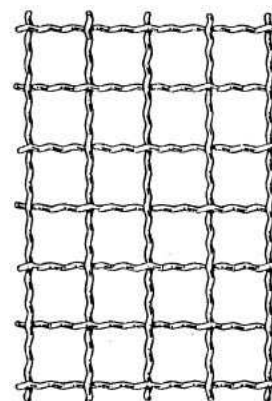

## PANNELLI SEMILAVORATI HALBVERARBEITETE PANELE

tappeto grigliato elettrosaldato per applicazioni orizzontali  
Schweisspress-Gitterroste für horizontale Verwendungen

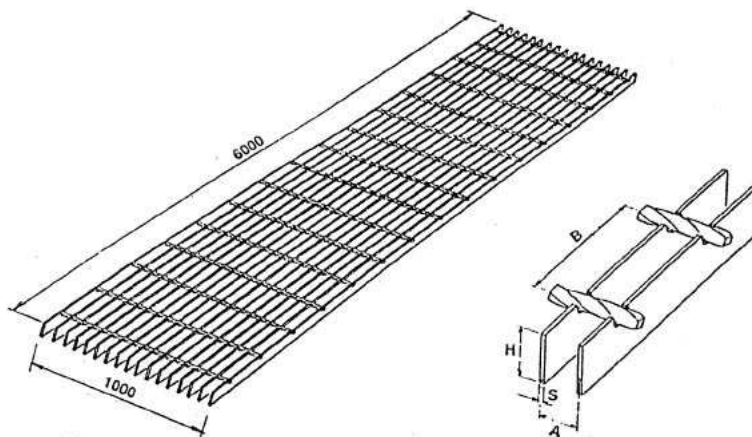

Maglia-Masche mm	Piatto-Flachstahl mm	Dimensioni-Abmessungen mm	Grezzo-Roh Kg/mq	Zincato-Verzinkt Kg/mq
15 x 76	25 x 2	6100 x 1000	28,1	30,1
25 x 76	25 x 2	6100 x 1000	17,7	18,9
	30 x 3	6100 x 1000	31,3	33,4
25 x 25	40 x 3	6100 x 1000	41,1	43,8
	25 x 2	6100 x 1000	46,0	21,8

## PANNELLI SEMILAVORATI HALBVERARBEITETE PANELE

tappeto grigliato pressato per applicazioni orizzontali  
Einpress-Gitterroste für horizontale Verwendungen

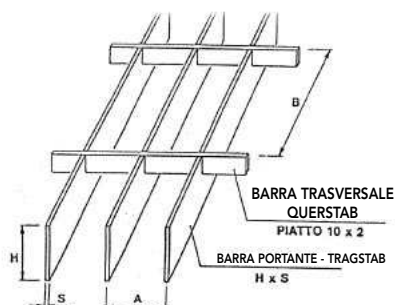

Maglia Masche mm	Piatto Flachstahl mm	Dimensioni Abmessungen mm	Grezzo Roh Kg/m <sup>2</sup>	Zincato Verzinkt Kg/m <sup>2</sup>
33 x 11	25 x 2	3000 x 1000	24	26,5
33 x 11	25 x 2	3000 x 1200	24	26,5

Possiamo fornire a richiesta griglie di dimensioni diverse. Wir können, auf Wunsch, Gitterroste mit anderen Maßen liefern.

## GRIGLIATI STIRATI - GESTRECKTE GITTERROSTE

Tipo-Typ	20	21	22
DL x DC mm	45 x 15	45 x 15	45 x 13,4
DL x DC reale mm	45 x 11,4	45 x 13,4	45 x 13,4
Avanz. <b>av</b> /mm	3,3	5	5
Spes./Dicke <b>sp</b> /mm	3	3	4
Peso/Gew. x m <sup>2</sup> Kg	13,8	17,5	24

### Dimensioni disponibili - Verfügbare Maße

Tipo-Typ	Largh./Breite DL mm	Lung./Länge DC mm
20	1000	2000
21	1000 1250 1500	2000 1500 3000
22	1000	2000

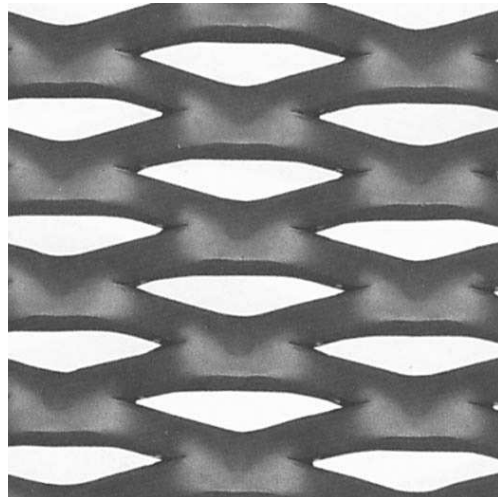

## RETI STIRATE - STRECKGITTER

Tipo-Typ	2	17	28
DL x DC mm	43 x 10	43 x 10	43x10
DL x DC reale mm	43 x 13	43 x 13	43x13
Avanz. <b>av</b> /mm	2,5	2,5	2,5
Spes./Dicke <b>sp</b> /mm	1	1,5	2
Peso/Gew. x m <sup>2</sup> Kg	2,75	4,2	5,5

### Dimensioni disponibili - Verfügbare Maße

Tipo-Typ	Largh./Breite DL mm	Lung./Länge DC mm
2 - 17 - 28	1000 1000-1250-1500 2000-2500	2000 6000 3400

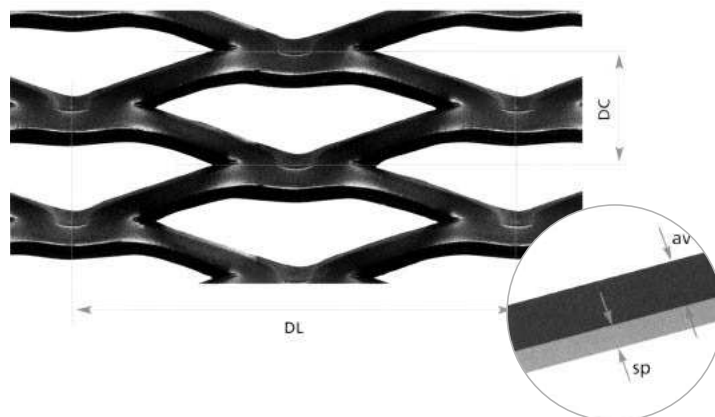
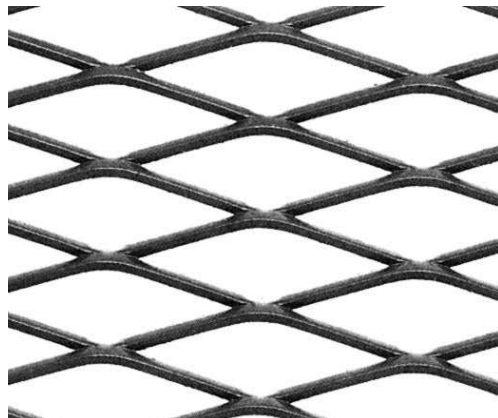

## GRADINI PER SCALE - TREPPENSTUFEN



**GRADINO IN GRIGLIATO STIRATO - STRECKKROSTSTUFE**  
ECO 43 X 10 sp 2 mm

DL mm	H mm	DC mm	Peso Kg cad Gewicht Kg
1000	72	250	5,6
900	72	250	5,3
800	72	250	4,9
700	72	200	3,4
600	72	200	3,1
500	72	200	2,7

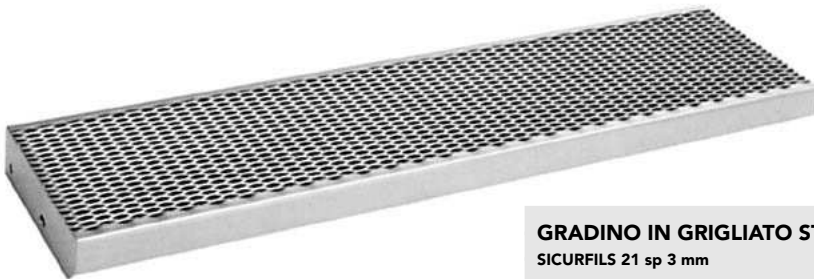

**GRADINO IN GRIGLIATO STIRATO - STRECKKROSTSTUFE**  
SICURFILS 21 sp 3 mm

DL mm	H mm	DC mm	Peso Kg cad Gewicht Kg
1200	73	300	15,7

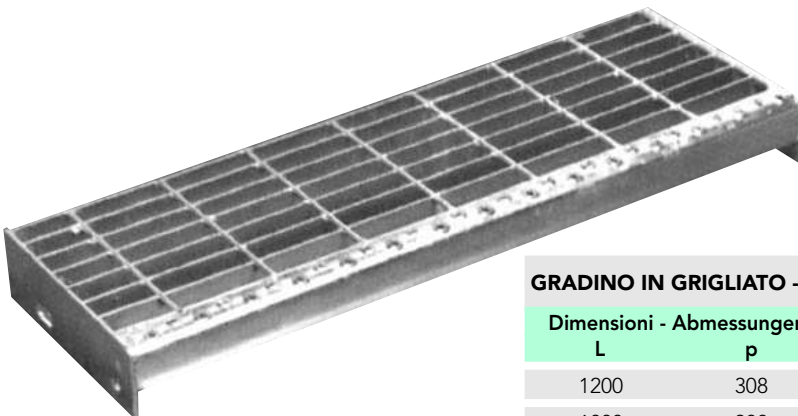

**GRADINO IN GRIGLIATO - GITTERROSTSTUFE**

Dimensioni - Abmessungen		Maglia	Piatto
L	p	Masse	Flachstahl
1200	308	15 x 75	25 x 2
1000	308	25 x 76	25 x 2
900	255	25 x 76	25 x 2
800	255	25 x 76	25 x 2